

## COMBINATION OF A THERMOBALANCE WITH A FLOW-THROUGH TUBULAR REACTOR

G. HAKVOORT and J.H.F. GRONDEL

Delft University of Technology, Department of Chemical Technology,  
Julianalaan 136, 2628 BL Delft, the Netherlands

### SUMMARY

The construction of a flow-through tubular reactor thermobalance combination is described. In this apparatus investigations can be made in aggressive gases with high flowrate and at high pressure. The apparatus is applied for the study of regenerative sorbent materials for desulfurization of combustion gases.

### INTRODUCTION

At our department the sulfur capture during the fluidized bed combustion of coal is investigated, using pellets of regenerative sorbent materials. The temperature and pressure regions are 850-1000°C and 1-10 bar respectively.

Thermogravimetry is an important technique for a fast screening of sorbents (ref. 1). The adsorption of SO<sub>2</sub> from a SO<sub>2</sub>/air mixture, the regeneration with hydrogen and the cycling behaviour of the sorbent pellets can be studied with conventional thermobalances, working at atmospheric pressure.

However, comparison with real reactor conditions is difficult on account of the following aspects:

- The contact between the sample, inside a crucible, and the gasphase, flowing along the sample is poor.
- The sample size is relatively small, giving problems with representative sampling of pellets.
- The sample behaviour at pressure higher than 1 atmosphere cannot be studied.
- Corrosion of the balance may occur, in consequence of the aggressive gases.
- The maximum gasflow is very low compared to the technical process.

Because commercial thermobalances, working at the required temperature and pressure region, are not available, it was decided to build a dedicated thermobalance, consisting of a quartz flow-through tubular reactor, mounted on top of an electronic balance.

Within the tubular reactor the gases flow through the sample, giving a very good contact between gasphase and sample. One problem is to get the gases in and out the reactor without disturbing the weight signal.

#### CONSTRUCTION

Kapteijn c.s. (ref. 2) described a flow reactor hanging down a balance. The gas is led in and out the reactor through teflon tubes (1.5 x 0.8 mm). However, we found in some preliminary investigations with teflon tubes, fixed to a balance, a continuous weight change, caused by strain relaxation and fluctuations of the room temperature. Stabilisation of the weight signal within about 1 mg was not possible. For this reason we decided to use tubes, consisting of stainless steel: We tested two kinds of tubes, with an outer and inner diameter of 0.8 x 0.5 mm and 0.5 x 0.25 mm respectively. Using a length of at least 70 cm tube with the smallest diameter (0.5 x 0.25 mm) appeared to be the best, showing fast stabilization of the weight signal after gasflow and pressure variation.

We also decided to fix the reactor on the top of the balance instead of hanging down the balance. This gives a more rigid construction. The temperature distribution is also better with the hot furnace above the balance. This gives less problems with heat shielding and avoids heating of the electronic part of the balance during long term experiments at high temperature. Of course, now the problem has to be solved of keeping the sample in the top of the U-shaped reactor tube.

A diagram of the constructed balance is shown in Figure 1.

The balance is an electronic Sartorius toploader, model A 200 S, with a weighing range of 202 g and a sensitivity of 0.1 mg. Via a digital to analog converter an analog signal is generated. A weight change of 100 mg corresponds to 1 Volt. The weight signal, together with the temperature signal, is plotted on a recorder against time.

The reactor tube is U-shaped and made of quartzglass, with a diameter of 7 x 5 mm and a length of 20 cm from inlet to top. With help of two spherical connections, consisting of ball joints fitted with O-rings and closed with special steel clips, the tube is attached to a carrier device, made of stainless steel (see Fig. 2.).

Flowrate and composition of the gasphase ( $H_2$ , air, 2%  $SO_2$  in air,  $N_2$ ) are controlled by electronic massflow controllers at the inlet, while the pressure is set at the outlet of the system by two electronic pressure regulators, with a control region of 0-2 and 2-10 bar respectively.

Depending on the diameter of the stainless steel tubes and the pressure and flowrate of the gases, a pressure difference exists between inlet and outlet

of the stainless steel tubes. These pressures are measured with two manometers. Owing to the symmetrical design the reactor pressure is exactly the average of these two measured pressures.

The furnace is kanthal wound and can reach a temperature of 1000°C. Via a Cr/Al thermocouple the furnace temperature is programmed by an electronic temperature programmer-controller combination (Eurotherm, type 812).

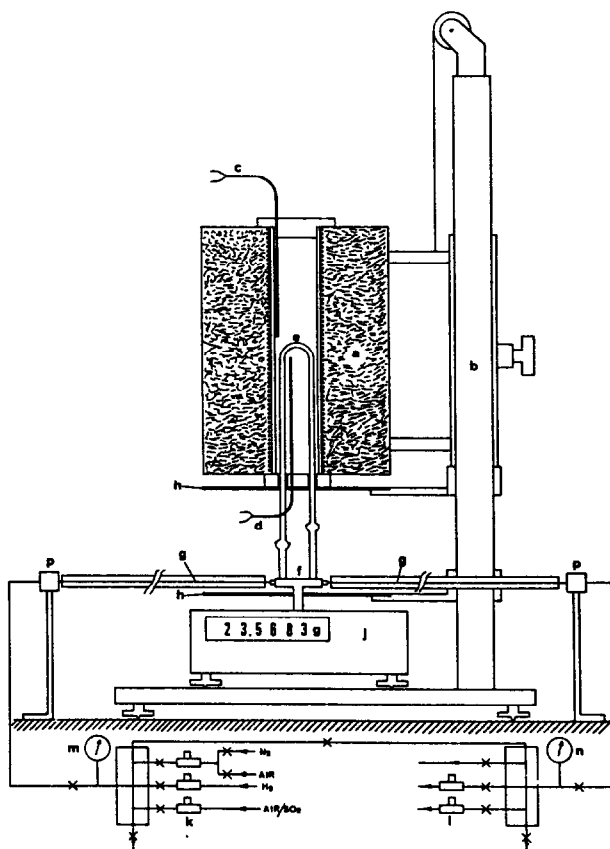

Fig. 1. Diagram of the thermobalance, combined with a flow-through tubular reactor.

a Furnace, b Device for raising and lowering the furnace, c and d thermocouples for temperature control and measurement respectively, e flow-through tubular reactor, made of quartzglass, f carrier device for the tubular reactor, mounted on top of the balance J, g stainless steel tubes (0.5 x 0.25 mm) for gas in- and outlet, h heat shields, k mass flow regulators for several gases, l pressure regulators at the outlet of the system, m and n manometers, p fixed connections for gas in- and outlet.

For safety reasons the quartz reactor is used up to a maximum temperature of 1000°C and a maximum pressure of 6 atmospheres. Further the balance/reactor combination is placed in a fume-chamber.

The sample consisting of pellets, is locked up in its place at the top of the quartz tube by two smaller quartz tubes (3 x 2 mm). These smaller tubes are fixed at the cold ends of the tubular reactor with help of two plugs, made of platinum gauze.

When powders are to be investigated instead of pellets, the sample can be locked up at the top of the reactor with quartz or alundum wool.

To prevent corrosion every part of the apparatus, that comes into contact with the reaction gases, is made of stainless steel or quartzglass.

In Fig. 2 a photograph of the central part of the apparatus is shown.

#### EXPERIMENTS AND DISCUSSION

A number of experiments are made:

- At first the equilibration of the balance after a sudden weight change is investigated. Fig. 3 shows that only a few minutes are needed for equilibration after a sudden change.



Fig. 2. Tubular reactor-thermobalance, central part of the apparatus.

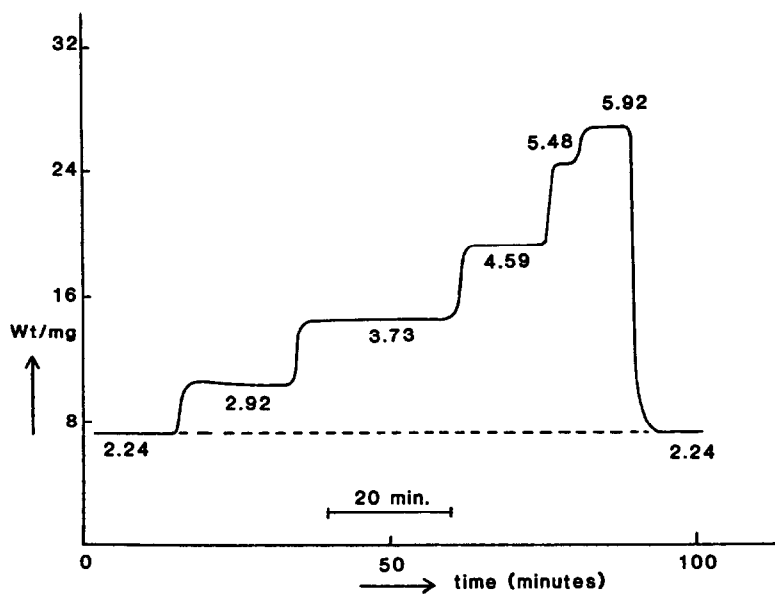

Fig. 3. Registration of the weight signal against time for different pressures in flowing air (100 mln/min) at a reactor temperature of 850°C. The numbers in the figure correspond to the pressure (bar).

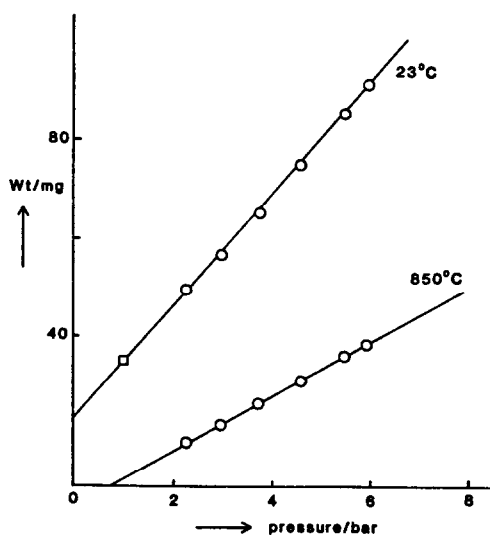

Fig. 4. Weight  $G$  as function of the reactor pressure  $P$  at 23 and 850°C. The slope of the straight lines  $dG/dP$  is 11.14 and 5.35 mg/bar at 23 and 850°C respectively.

- The Figures 3 and 4 also demonstrate the influence of gaspressure and reactortemperature on the weight signal.

For conventional thermobalances this influence is rather small, depending on the change of the upward power with variations of pressure and temperature. In case of the tubular reactor the weight of the gas in the reactor tube is included in the weight signal, so the weight changes much more than in the first case.

- Because of the small diameter of the stainless steel tubes, a pressure difference may exist between inlet and outlet, depending on the flow rate and the absolute pressure.

For an air flow of 100 ml /min this pressure difference is for instance 2.40 bar at a reactor pressure of 2.24 bar, and 0.88 bar at a reactor pressure of 6.00 bar.

- The influence of the flow rate on the weight signal is very small, provided that the reactor pressure is kept constant. So, at a pressure of 2.90 bar and 850°C the weight signal varies from 22.5 mg to 24.2 mg for 100 and 200 ml /min airflow respectively.
- The gasflowrate within the tubular reactor is high, compared to a conventional thermobalance. At a flow rate of 200 ml /min and a temperature of 850°C a conventional thermobalance, with a tube diameter of 2 cm, gives a flowrate of 4.36 cm/s at a pressure of 1 atmosphere, while the tubular reactor, filled with a sample with porosity 0.5, gives a flowrate of 46.5 cm/s at a pressure of 3 atmospheres.
- After these preliminary experiments a start was made with the investigation of regenerative sorbents for desulfurization of combustion gases. The sorbent consisted of  $\alpha$ -  $Al_2O_3$  pellets, impregnated with about 8.4 wt % CaO (see ref. 1).

Important reactions are:

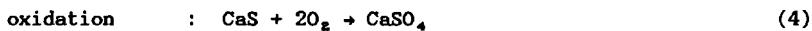
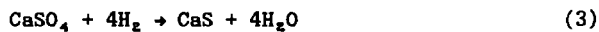
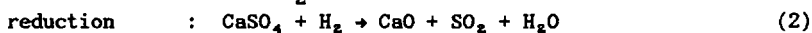
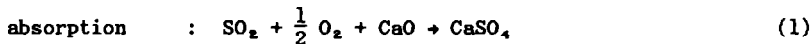

A complete absorption/regeneration cycle is shown in fig. 5. Compared to similar experiments with a conventional thermobalance there are several differences (see ref. 1):

- The absorption proceeds much faster in the tubular reactor (region I of Fig. 5, with a weight increase of 109.9 mg up to point a).

In Table 1 some absorption experiments, according to reaction (1), are compared with each other for several geometrical conditions. These experiments clearly indicate that the tubular reactor gives a much better contact between gasphase and sample, compared to conventional thermogravimetry. This is due to the fact that the gas flows through the sample, in contrary with the conventional thermobalance, where the gas flows at the outside of the sample container.

- b. After completion of the absorption reaction, when almost all CaO has been converted into CaSO<sub>4</sub>, in the conventional thermobalance experiments a constant weight is reached.

At the tubular reactor the weight still continues to increase after completion of the absorption reaction, but at a lower rate than during this reaction (see Fig. 5, region II). At the same time condensation was observed in the cold outlet part of the reactor. This condensation

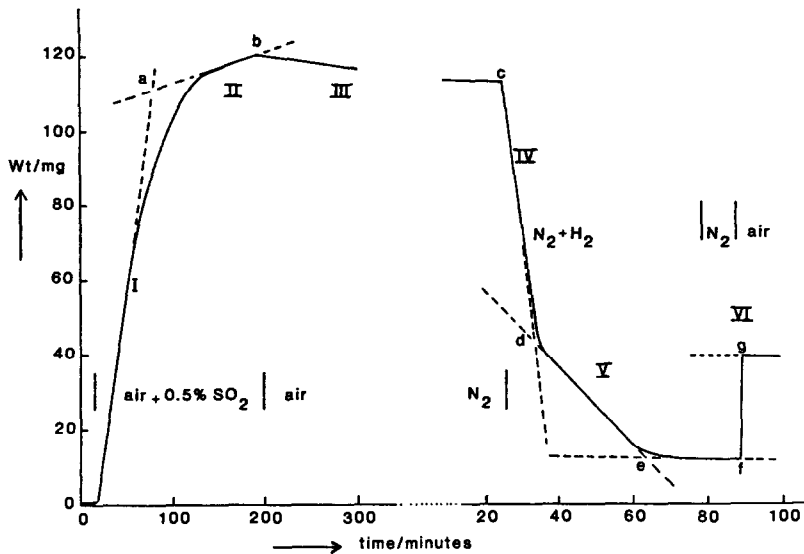

Fig. 5. Testing of 0.95 g CaO/Al<sub>2</sub>O<sub>3</sub> pellets in flowing gas mixtures at a flowrate of 100 ml/min. The reactor temperature is 850°C and the pressure 2.22 bar (absolute).

- I Uptake of SO<sub>2</sub>, according to:  $\text{CaO} + \text{SO}_2 + \frac{1}{2}\text{O}_2 + \text{H}_2\text{O}$   
 II Condensation of SO<sub>3</sub>/H<sub>2</sub>SO<sub>4</sub> at the outlet of the reactor.  
 III Evaporation of the condensation.  
 IV and V Reduction in N<sub>2</sub>/H<sub>2</sub> (flowrates 100 and 5 ml/min respectively)  
 $\text{CaSO}_4 + \text{H}_2 \rightarrow \text{CaO} + \text{SO}_2 + \text{H}_2\text{O}$  and  $\text{CaSO}_4 + 4\text{H}_2 \rightarrow \text{CaS} + 4\text{H}_2\text{O}$   
 VI Oxidation of CaS:  
 $\text{CaS} + y\text{O}_2 \rightarrow \text{CaSO}_4$  ( $y=2$ ) or  $\text{CaO} + \text{SO}_2$  ( $y=1\frac{1}{2}$ )  
 point a corresponds to a complete reaction of all CaO into CaSO<sub>4</sub> (weight increase 109.9 mg).

TABLE 1

Effect of sample geometry on the efficiency  $\epsilon$  of sulfur capture for CaO/Al<sub>2</sub>O<sub>3</sub> pellets.

Gasflow 0,5% SO<sub>2</sub> in air, 200 ml /min. Reactortemperature 850°C. A and B: conventional thermobalance with 0.6 g sample in a closed alundum crucible (A) and an open crucible mode of platinum gauze (B), C: Tubular reactor.

geometry	reactor pressure bar	$\epsilon$ %
A	1.0	13
B	1.0	36
C	3.0	93

consists of H<sub>2</sub>SO<sub>4</sub> and SO<sub>3</sub>, formed in the reactor at high temperature, according to the reaction:

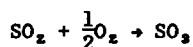

This SO<sub>3</sub> can react with water vapour at low temperature:

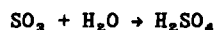

The first reaction is catalysed by the sample, but much better by platinum. For this reason the sample may not be enclosed between platinum plugs, directly in the hot zone. In a first experiment, where the sample was enclosed between platinum gauze instead of quartz tubes, a lot of condensation was formed. The formation of sulfuric acid demands water vapour. So it is necessary to dry the inlet gases very well, because specially sulfuric acid is very aggressive and attacks stainless steel. In region III the condensation evaporates slowly.

- c. The reduction can give two different products: CaO and CaS. In Fig. 5 it is seen that the reduction proceeds in two steps: a fast step (region IV) and a slow step (region V).

Probably the fast step corresponds with reaction (2), the formation of CaO. This CaO is stabilized by Al<sub>2</sub>O<sub>3</sub> with formation of calciumaluminate (ref. 3, 4). This step has a weight loss of 59.7 mg, corresponding to 54.3 % of the original CaSO<sub>4</sub>. The slope of the straight part (line c-d in Fig. 5.) is 2.660 mg/min, corresponding to a hydrogen consumption of 0.745 ml /min.

The second step corresponds to reaction (3), the formation of CaS, that cannot react with Al<sub>2</sub>O<sub>3</sub>. The weight loss is 40.2 mg. corresponding to 45.7 % of the original CaSO<sub>4</sub>. The slope of the straight part of this step (line d-e) is 0.5367 mg/min, corresponding to a hydrogen consumption of



0.752 ml /min. Since the hydrogen flow is 5 ml /min, the consumption is only 15 % and the same for both reactions. Therefore it may be concluded that not the chemical reaction is rate determining, but the transport of reactants and products through the gasphase or in the pores of the sample (ref. 5).

- d. The weight increase of the oxidation step VI is 27.0 mg, caused by a combination of the reactions (4) and (5). Assuming that all CaS reacts into  $\text{CaSO}_4$  or  $\text{CaO}$ , it can be calculated that 74 % of the CaS reacts according to reaction (4), the formation of  $\text{CaSO}_4$ .
- e. Table 2 gives an impression of the sulfur absorption at very low  $\text{SO}_2$  concentrations (400 or 200 ppm). The absorption capacity at 850°C is still very good, but drops down at 1000°C. This can be explained by thermodynamic reasons: at 1000°C the calciumaluminate in the pellets is too stable and the formation of  $\text{CaSO}_4$  is prevented.

#### CONCLUSIONS

- A tubular reactor, combined with a thermobalance, is very suitable for study of the reaction of gases with solid samples.
- The efficiency of gas-solid reactions is in the tubular reactor balance very high compared to conventional thermobalances.
- Aggressive gases can be used, because the balance is separated from the reactor.

TABLE 2

Efficiency of sulfurcapture  $\epsilon$  as function of reactor pressure P at low  $\text{SO}_2$  concentrations.

Sample: 0.95 g  $\text{CaO}/\text{Al}_2\text{O}_3$  pellets; f is the fraction of CaO, converted into  $\text{CaSO}_4$ , T = reactor temperature. The flowrate of  $\text{SO}_2$  is 0.04 ml /min, corresponding to a maximum uptake of 0.143 mg  $\text{SO}_3$ /min.

f %	air flowrate ml /air	P bar	T °C	rate of weight increase mg/min	$\epsilon$ %
16	102	2.27	850	0.102	72
21	202	3.04	"	0.122	85
27	"	4.40	"	0.149	104
33	"	5.42	"	0.142	99
41	"	3.14	"	0.145	101
55	"	3.14	"	0.139	97
100	"	3.14	"	0.048	33*
15	"	3.14	1000	0.082	57*
20	"	3.14	1000	0.031	22*

\* condensation of  $\text{SO}_3$  at the cold outlet of the reactor.

- The flowrate in the tubular reactor is much higher than in conventional thermobalances, so comparison with technical processes is more realistic.
- The tubular reactor thermobalance is very suitable for investigations at high temperature and pressure, depending on the material of the reactor.
- The apparatus is very suitable for the investigation of regenerative sorbent materials for the desulfurization of combustion gases.
- The various reactions corresponding to the absorption and regeneration can exactly be determined.

#### ACKNOWLEDGEMENT

The authors wish to thank the technicians, who helped to construct the apparatus, particularly mr. A. Molenwijk, T. v.d. Plas, J. Poot, P.J. Molenkamp and W. van Heest.

Further we thank Dr. F. Kapteijn from the University of Amsterdam for his valuable technical advises.

This investigation is supported by the Netherlands Management Office for Energy Research PRO (contract number 20.35-016.30) and by the Commission of the European Communities (contract number EN3F-0014-NL (GDF)).

#### REFERENCES

1. G. Hakvoort, C.M. van den Bleek, J.C. Schouten and P.J.M. Valkenburg, TG study of sorbent materials for desulfurization of combustion gases at high temperature, submitted for publication in *Thermochimica Acta*.
2. F. Kapteijn, M. van Son and J.A. Moulijn, Measurement of reactivity and surface area development during CO<sub>2</sub> gasification of activated carbon, *Carbon '82*, 166-168.
3. J.M. Chen and R.T. Yang, Fluidized-bed combustion of coal with lime additives. Kinetics and mechanism of regeneration of the lime sorbent, *Ind. Eng. Chem. Fundam.*, Vol. 18, No. 2 (1979) 134-138.
4. L.A. Ruth and G.M. Varga, Jr., New regenerable sorbents for fluidized bed coal combustion, *Env. Sci. & Tech.*, 13, No. 6 (1979) 715-720.
5. G. Hakvoort, W. van der Klugt, Y. Timmerman and L.L. van Reijen, DSC calibration for the methanation reaction, catalyzed by Ni/Al<sub>2</sub>O<sub>3</sub> pellets, *Thermochim. Acta*, 85 (1985) 319-322.